

Timber Door Solutions



Door Locks
Door Handles
Letterplates
Door Accessories





nanocoast®
UAP



nanocoast®
UAP





UAP LIMITED

*Your award-winning
complete door and window
hardware solutions partner.*

A smarter Door Lock with simple access control.

The IONIC lock by Fullex-ai with timeless design enables simple access using a Smartphone App. The access logins can be easily managed via mobile phone. An additional feature of the app is the access protocol, in which you can see which users have opened the door.

Due to the simple installation and the easy-to-use access control, the Ionic electronic lock by Fullex-ai is ideal for any domestic properties and social housing.

With the integrated power supply and wireless charging, you can open and close the door using Bluetooth on your mobile phone. The simple and quick installation makes it ideal for factory fitting.

You can register infinity number of door openings in the smartphone App and up to 1500 on the lock itself!

Quick and easy installation

User administration and logging via App

Fits every door

GB Granted patent and a European Patent Application

Unlocking via Bluetooth

Dedicated security escutcheon available

Comes with up to 10 year mechanical guarantee



IMMEDIATE CONFIRMATION THE DOOR IS LOCKED



WIRELESS CHARGING



ULTRA SECURE



BLUETOOTH COMMUNICATION



The IONIC Electronic Lock by Fullex-ai is accessible using the Smartphone App which comes with a comprehensive user manual. The App is available to download from Google App Store or Apple Store. It is necessary to turn on the Bluetooth module to use the application. You must turn on the location service too on Android.

The IONIC Electronic Lock by Fullex-ai comes with a key fob which can be paired with the App for even easier door access.

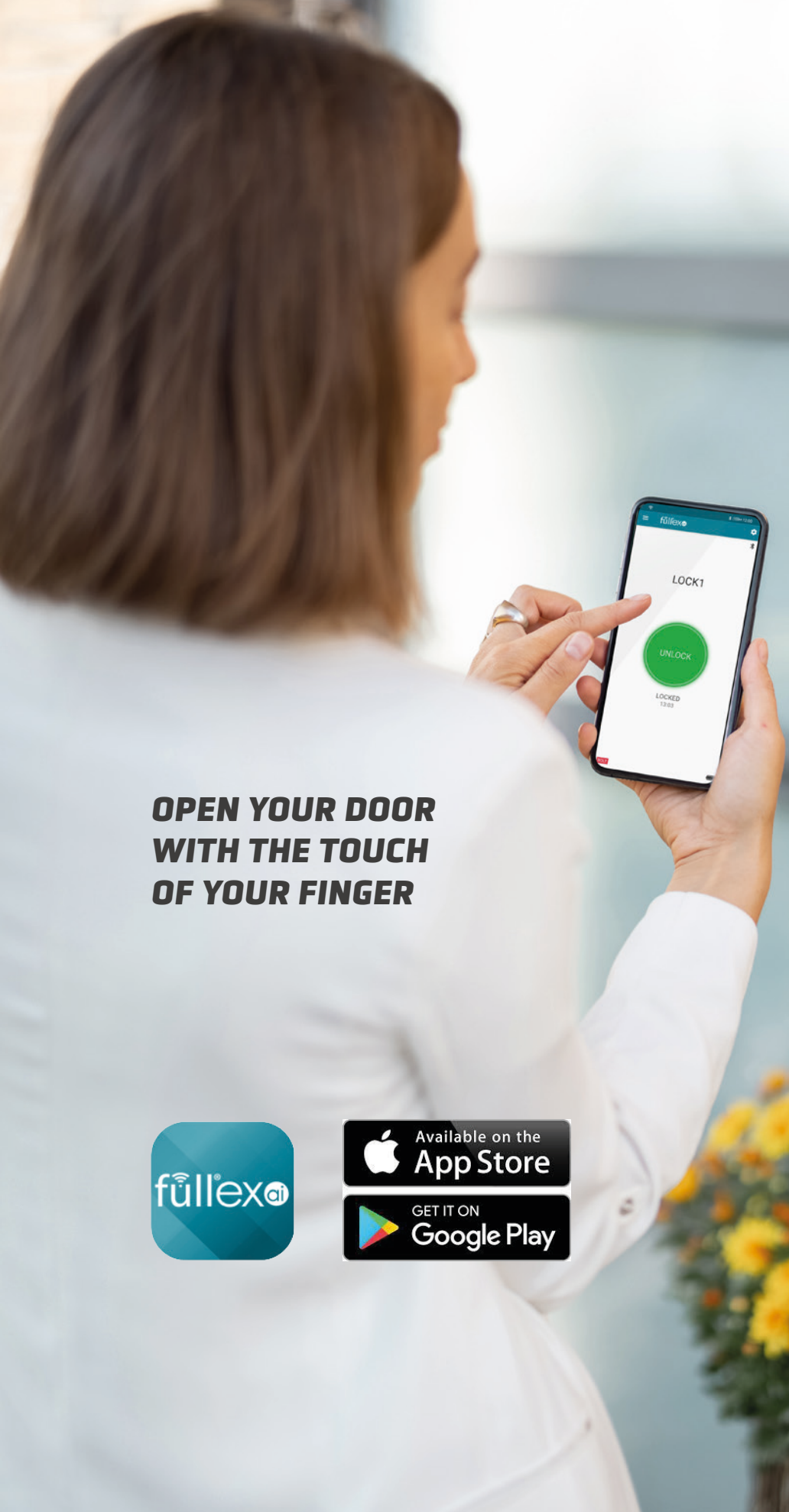

**OPEN YOUR DOOR
WITH THE TOUCH
OF YOUR FINGER**



fullex[®] Flexi Lock



Flexi lock - a future of multipoint locks.

Thanks to our revolutionary system, the flexi lock can be paired with one of our beautiful rose handles and match with handles inside or use classic door handles on a backplate.

One solution for every door.

We offer a range of front door handles aimed at fabricators who want to provide a high-quality designed front door handle to help their customers improve front door security.



**DESIGNED FOR
TIMBER, COMPOSITE
AND ALUMINIUM DOORS**



**EASY INSTALLATION
SAME PREP DETAILS AS XLC LOCK
45MM BACKSET**



**IDEAL WITH
1★ or 3★ CYLINDER**



**COMPATIBLE WITH
LEVER ON ROSE
OR ON BACKPLATE**



**COMPETITIVELY
PRICED**



**ONE MULTI-POINT
LOCK TO SECURE
THEM ALL**

fullex[®] TIMBER DOUBLE DOOR LOCKS

The direct fix double door lock is based on the 220 Pro lock mounted on a 16mm full height cover plate for the master door, the slave door side is also based on the 220 Pro centre case in a simplified version with keep adjustment incorporated onto the faceplate.

The lock is made to fit directly into the edges of a over-rebated double door set.

Composite Doors

Timber Doors

Deadbolt throws when the handle is lifted

2 opposing steel hooks, deadbolt and latch

Inline split spindle lock

Easily reversible latch

Includes latch hold back snib on lock faceplate

2200mm X 16mm square ends

Composite and timber over rebated double doors

Comes with a 10 year guarantee

Keeps are integrated into the slave door lock face plate

Comes with an anti-drill plate for extra security

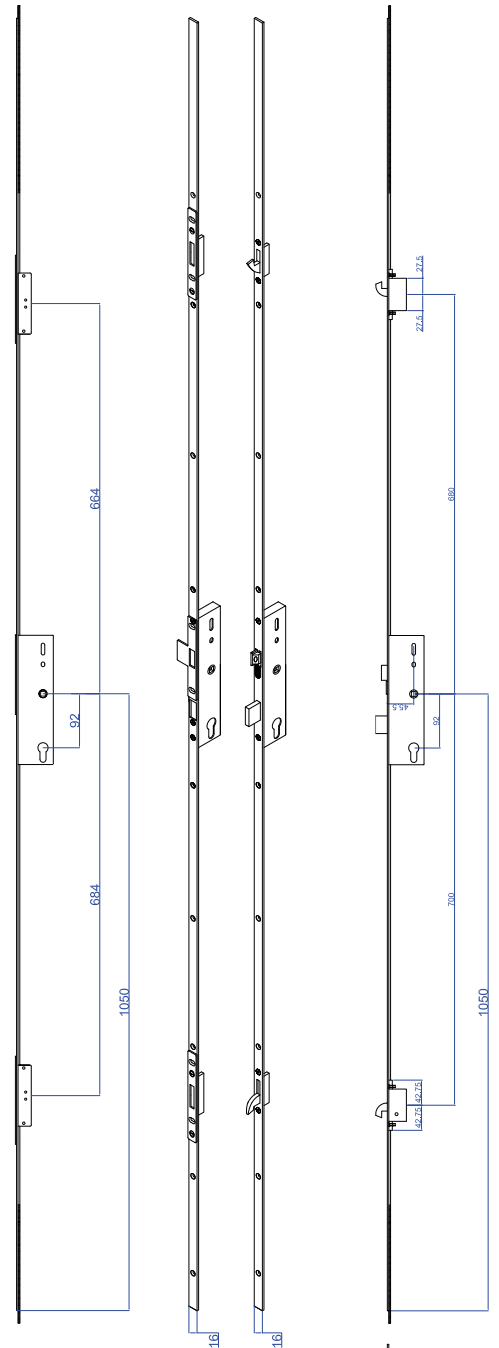

Secured by Design



Police Preferred Specification

PAS 24

ENHANCED SECURITY PERFORMANCE APPROVED

For maximum security the Timber Double Door Lock can be used with the Kinetica 3 star BSI Kitemarked TS007 cylinder.



fullex[®] Key Wind Lock

SINGLE DOORS

The Fullex Key Wind lock uses the key or the thumbturn to engage and retract the bolts and the latch. The Fullex Key Wind lock was developed to stop anyone getting in without a key when the door is closed. Our system uses the latch to do this. Once the door is closed you cannot move the latch unless you have a key. If a burglar tried to open the door, say for example if someone has entered the house

with shopping, then they cannot get in. The Fullex Key Wind Lock have minimum key turning with less than a half a turn.

The Fullex Key Wind Lock system offers low maintenance, economic cost and easy to use functionality.

Composite
Doors

Timber
Doors

Aluminium
Doors

Based on the Fullex Crimebeater lock

Operated by thumbturn or key-key cylinder

Non-handed easily reversible latch

Designed for use with pull handles

Snib latch retention on face plate

Dedicated security escutcheon available

Comes with a 10 year guarantee

Ideal for doors with a pull handle



Technical Data

45mm backset
3 dead bolts
Reversible latch
Cover plate 20mm wide, 1720mm long

Top and Bottom Hook

Chrome plated steel top and bottom bolts

Centre bolt

Stainless steel centre bolt

The best and most economical system, is having a package of Pull Handle, Key Wind Lock, High Security Escutcheon and 1 Star cylinder, and so we developed a matching escutcheon that fits the Key Wind Lock system.





**Designed
for door with
a pull handle**

KEY WIND DOOR LOCK

Technical Data

45mm backset
3 dead bolts
Reversible latch
Cover plate 20mm wide, 1720mm
long

Top and Bottom Hook

Chrome plated steel top and bottom bolts

Centre bolt

Stainless steel centre bolt

fullex[®] TIMBER DOOR LOCKS

Fullex door locks have been designed to offer high security and long term reliability. They are suitable for all major timber profiles and boast exceptional security as well as durability.

XL CRIMEBEATER



Comes with an anti-drill plate for extra security

Integral hold back latch function on lock faceplate

Dual spindle for front / back door options

Easily reversible latch as standard

Option 1 - 2 tapered steel hooks, latch and sintered centre hook

Option 2 - 2 deadbolts, centre hook and latch

Various adjustable security keep sets available

CRIMEBEATER & CRIMEBEATER 220 PRO



Dual or single spindle option

Integral hold back latch function on lock faceplate

2 tapered steel hooks, deadbolt and latch or 3 deadbolts and latch

Easily reversible latch as standard

Various adjustable security keep sets available

For use with composite and timber doors

Comes with an anti-drill plate for extra security

PATIO LOCK



PAS 24 tested

Available in 1414mm 6 hook and 1753mm 8 hook versions

Opposing stainless steel hooks and centre anti lift-bolt

Inclusive mishandling device to prevent damage to lock and keep

Shootbolt extendable at top and bottom as standard

One piece stainless steel keep

PATIO INTERLOCK



PAS 24 tested

Interlock with Bi-directional hooks

Comes with a 10 year guarantee

2 pane version and 4 pane version

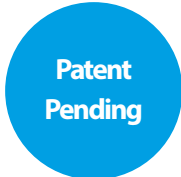

SLUM SHUT AUTO LOCK

Secured by Design



Police Preferred Specification



Based on the Fullex Crimebeater lock

Dual Spindle Lock

Supplied complete with strike plate

Easily reversible latch as standard

Tested to 50,000 full cycles

For use with composite and timber doors

Comes with a 10 year guarantee

GEMINI

Secured by Design



Police Preferred Specification



Comes with an anti-drill plate for extra security

Integral hold back latch function on lock faceplate

Dual spindle for front / back door options

Easily reversible latch as standard

Option 1 - 2 tapered steel hooks, latch and sintered centre hook

Option 2 - 2 deadbolts, centre hook and latch

Various adjustable security keep sets available

BIN LOCK

Secured by Design



Police Preferred Specification



Available in 1414mm 6 hook and 1753mm 8 hook versions

Opposing stainless steel hooks and centre anti lift bolt

Inclusive mishandling device to prevent damage to lock and keep

Shootbolt extendable at top and bottom as standard

One piece stainless steel keep

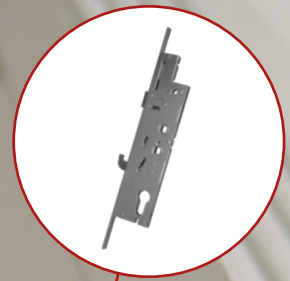

KINETICA+ K4

The Fullex Kinetica+ K4 Euro cylinder backs up its name as a game changer, by providing you with all the features you would expect from a quality lock but with much more in its locker. Securing premises with a proven performance that's been tested to 100,000 cycles and reinforced by a two-year guarantee.

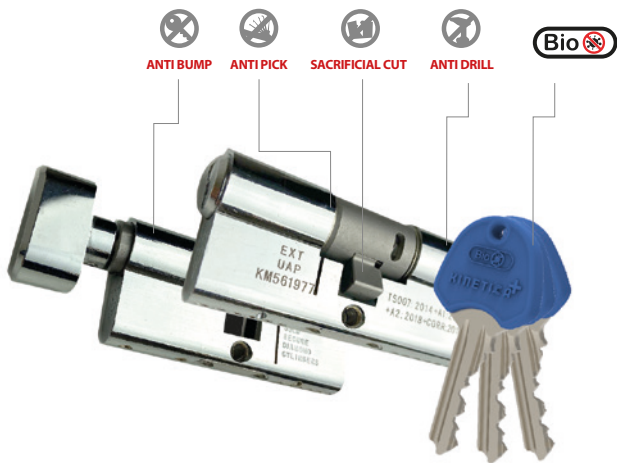

KINETICA+ K4 HORIZONTAL

A new horizontal version of our industry leading Kinetica+ K4 3-star cylinder. As an additional security measure, the Kinetica+ K4 Horizontal cylinder has been designed to allow only single-orientation key insertion. The new horizontal keyway has six dimple pins and five laser track side pins, creating the potential for over 13 million differs, and making the lock even more difficult to pick.

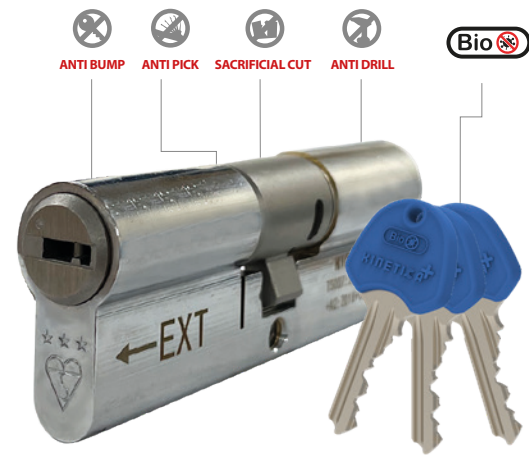

ZEROLIFT ADVANCE

UAP have developed a large range of 1* Kitemarked euro cylinders which conform to EN1303:2005 standards. The cylinder has been re-engineered from our original Zerolift cylinder, and not only does it combine all the original Zerolift features, but the Zerolift Advance cylinders are also packed with even more functions.

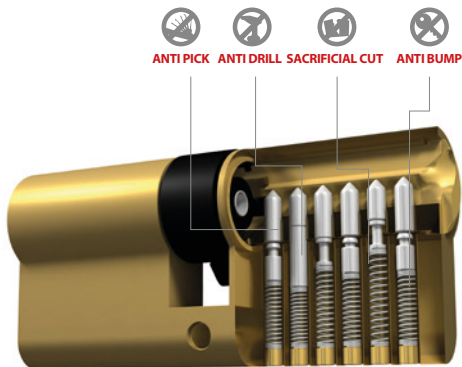

ZEROLIFT ADVANCE

Each and every cylinder is an extremely high quality 6 pin cylinder, with added security features. All cylinders come complete with anti-pick mushrooms, anti-drill pins and use our brand new patented anti-bump timing pin system. The cylinders are also designed to operate as smoothly and effectively as possible.

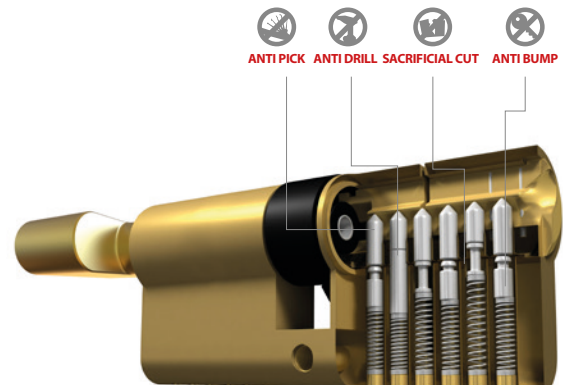

PART OF THE
UAP
LIMITED
REGISTRATION
SCHEME



fullex
UAP



EURO CYLINDERS

SLIM PULL HANDLES

- Made from 1.5mm 316 grade stainless steel
- 32mm diameter for sturdier construction
- Salt spray tested to ASTM B117 for 2,000 hours
- Each handle comes with a LIFETIME coating guarantee!
- 3 fixing methods available – hidden, bolt through and back to back



Finish	Size	Material Construction	Coating Guarantee	Product Code
Satin Stainless	900mm	316 Grade Stainless Steel	LIFETIME	PH900S-SSS-SLIM
Satin Stainless	1200mm	316 Grade Stainless Steel	LIFETIME	PH1200S-SSS-SLIM
Satin Stainless	1500mm	316 Grade Stainless Steel	LIFETIME	PH1500S-SSS-SLIM
Satin Stainless	1800mm	316 Grade Stainless Steel	LIFETIME	PH1800S-SSS-SLIM

STRAIGHT PULL HANDLES

- 38mm diameter for sturdier construction
- Made from high grade stainless steel
- Salt spray tested to ASTM B117 for 2,000 hours
- Each handle comes with a LIFETIME coating guarantee!
- 3 fixing methods available – hidden, bolt through and back to back



Size	Material Construction	Coating Guarantee	Satin Silver	Mirror Polished
400mm	316 Grade Stainless Steel	LIFETIME	PH400S-SSS-NANOCOAST	-
600mm	316 Grade Stainless Steel	LIFETIME	PH600S-SSS-NANOCOAST	-
900mm	316 Grade Stainless Steel	LIFETIME	PH900S-SSS-NANOCOAST	PH900S-MPSS-NANOCOAST
1200mm	316 Grade Stainless Steel	LIFETIME	PH1200S-SSS-NANOCOAST	PH1200S-MPSS-NANOCOAST
1500mm	316 Grade Stainless Steel	LIFETIME	PH1500S-SSS-NANOCOAST	PH1500S-MPSS-NANOCOAST
1800mm	316 Grade Stainless Steel	LIFETIME	PH1800S-SSS-NANOCOAST	PH1800S-MPSS-NANOCOAST

ALL FIXINGS ARE INCLUDED WITH OUR BAR PULL HANDLES

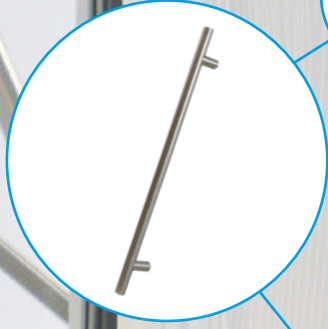
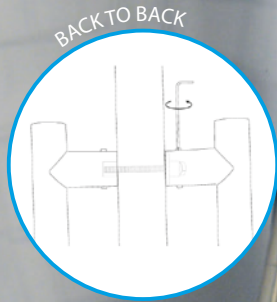
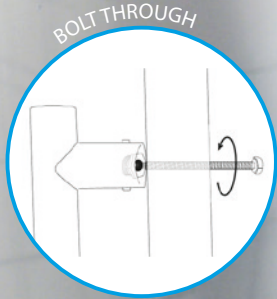
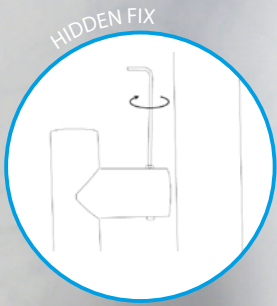

nanocoast®
UAP

PULL HANDLES

nanocoast®

OFFSET PULL HANDLES

- 38mm diameter for sturdier construction
- Made from high grade stainless steel
- Salt spray tested to ASTM B117 for 2,000 hours
- Each handle comes with a LIFETIME coating guarantee!
- 3 fixing methods available – hidden, bolt through and back to back

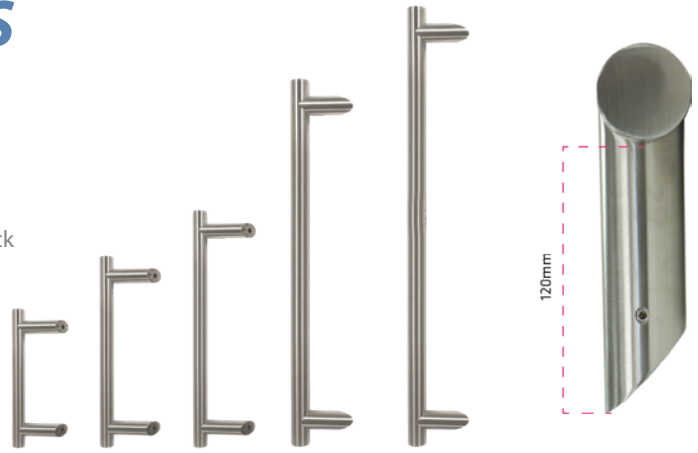

Finish	Size	Material Construction	Coating Guarantee	Product Code
Satin Stainless	400mm	316 Grade Stainless Steel	LIFETIME	PH400OFF-SSS-NANOCOAST
Satin Stainless	600mm	316 Grade Stainless Steel	LIFETIME	PH600OFF-SSS-NANOCOAST
Satin Stainless	900mm	316 Grade Stainless Steel	LIFETIME	PH900OFF-SSS-NANOCOAST
Satin Stainless	1200mm	316 Grade Stainless Steel	LIFETIME	PH1200OFF-SSS-NANOCOAST
Satin Stainless	1500mm	316 Grade Stainless Steel	LIFETIME	PH1500OFF-SSS-NANOCOAST
Satin Stainless	1800mm	316 Grade Stainless Steel	LIFETIME	PH1800OFF-SSS-NANOCOAST



SQUARE PULL HANDLES

- 40mm x 20mm diameter for sturdier construction
- Made from high grade stainless steel
- Salt spray tested to ASTM B117 for 2,000 hours
- Each handle comes with a LIFETIME coating guarantee!
- 3 fixing methods available – hidden, bolt through and back to back



Finish	Size	Material Construction	Coating Guarantee	Product Code
Satin Stainless	900mm	316 Grade Stainless Steel	LIFETIME	PH900SQUARE-SSS-NANOCOAST
Satin Stainless	1200mm	316 Grade Stainless Steel	LIFETIME	PH1200SQUARE-SSS-NANOCOAST
Satin Stainless	1500mm	316 Grade Stainless Steel	LIFETIME	PH1500SQUARE-SSS-NANOCOAST



D-SHAPED PULL HANDLES

- 38mm diameter for sturdier construction
- Handle is made from 316 grade stainless steel
- Salt spray tested to ASTM B117 for 2,000 hours
- Each handle comes with a LIFETIME coating guarantee!
- 3 fixing methods available – hidden fix, bolt through and back to back



Size	Material Construction	Coating Guarantee	Standard Fix	Hidden Fix
300mm	316 Grade Stainless Steel	LIFETIME	PH300DSHAPE-SSS-NANOCOAST	PH300DSHAPE-SSS-HF-NANOCOAST



ALL FIXINGS ARE INCLUDED WITH OUR BAR PULL HANDLES

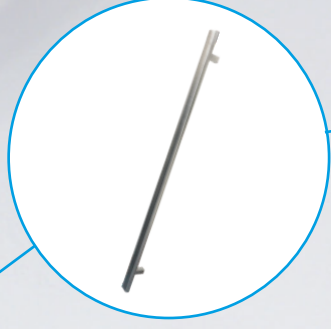



DESIGNER RANGE PULL HANDLES

nanocoast®

The Designer Pull Handles range is made from thick high grade stainless steel and features a stylish design with shiny mirror polished elements. It has a diameter of 38mm for sturdier construction. This range is part of the Nanocoast range, coming with a LIFETIME coating guarantee. The bolt through fixing gives a neater finish and as high grade Stainless Steel is used, the product will not rust and so there will be no leakage if it rains. The handles also comes with an Allen Key and 2 Allen Bolts on each of the up-stands, as well as two fixing points with an individual plate on each.



Finish	Size	Material Construction	Coating Guarantee	Product Code
Satin Stainless	1500mm	316 Grade Stainless Steel	LIFETIME	PH1500S-AURA-NANOCOAST
Satin Stainless	1500mm	316 Grade Stainless Steel	LIFETIME	PH1500S-SPEAR-NANOCOAST
Satin Stainless	600mm	316 Grade Stainless Steel	LIFETIME	PH600S-WAVE-NANOCOAST
Satin Stainless	1500mm	316 Grade Stainless Steel	LIFETIME	PH1500S-QUAD-NANOCOAST
Satin Stainless	1500mm	316 Grade Stainless Steel	LIFETIME	PH1500S-DESIGNERSLIM-NANOCOAST
Satin Stainless	1500mm	316 Grade Stainless Steel	LIFETIME	PH1500S-TRIUMPH-NANOCOAST



AURA



SPEAR



WAVE



QUAD



DESIGNER SLIM



TRIUMPH

2* HIGH SECURITY ESCUTCHEON

- BSI 2* Kitemarked
- Secured by Design
- Made from 316 grade stainless steel
- Salt spray tested to ASTM B117 for 2,000 hours
- Each escutcheon comes with a LIFETIME coating guarantee!

Finish	Material Construction	Coating Guarantee	Product Code
Mirror Polished	Stainless Steel	LIFETIME	HSEMPSS-NANOCOAST
PVD Gold	Stainless Steel	LIFETIME	HSEPVDG-NANOCOAST
Satin Stainless	Stainless Steel	LIFETIME	HSESSS-NANOCOAST



STANDARD ESCUTCHEON

- Made from 316 grade stainless steel
- Salt spray tested to ASTM B117 for 2,000 hours
- Each escutcheon comes with a LIFETIME coating guarantee!
- Perfect for the UAP range of Stainless Steel Pull Handles
- Contemporary design with a smooth finish

Finish	Material Construction	Coating Guarantee	Product Code
Satin Stainless	Stainless Steel	LIFETIME	HSESSS-NANOCOAST



2* HIGH SECURITY PULL ESCUTCHEON

- BSI 2* Kitemarked
- Secured by Design approved
- Tested to ISO 9227:2012
- Pull grip feature for comfort
- Made from 316 grade stainless steel
- Each escutcheon comes with a LIFETIME coating guarantee!

High Security Pull Escutcheon

Finish	Material Construction	Coating Guarantee	Product Code
Mirror Polished	Stainless Steel	LIFETIME	HSEMPSS-PULL-NANOCOAST
Satin Stainless	Stainless Steel	LIFETIME	HSESSS-PULL-NANOCOAST



Internal High Security Pull Escutcheon



Finish	Material Construction	Coating Guarantee	Trade Pack
Mirror Polished	Stainless Steel	LIFETIME	HSESSS-PULL-INTERNAL
Satin Stainless	Stainless Steel	LIFETIME	HSEMPSS-PULL-INTERNAL

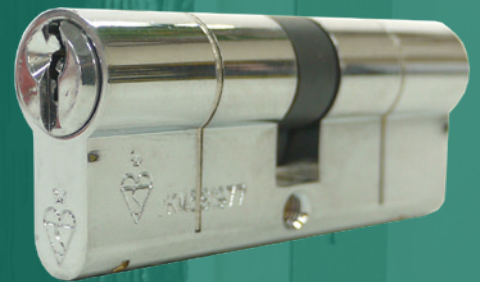

1* Cylinder Solution

The escutcheons are ideal to be combined with the ZeroLift 1* Kitemarked high security cylinder. Combining the Nanocoast high security escutcheon with the ZeroLift 1* cylinders will give you a professional security solution.

We have also developed a specially sized 30/35 (65mm) cylinder which is the perfect size cylinder to use with the Nanocoast high security escutcheons!

Created in accordance with the British Standard Kitemark, and also awarded "Secured by Design" approval by the Association of Police Officers, the high quality 6 pin double Kitemarked euro cylinder can be fitted to any door in order to ward off criminals that attempt to use the most popular break-in methods.

TS008 LETTERPLATES

THE SOTERIAN TS008 LETTERPLATE

Named after the Goddess of Safety, The Soterian letterplate is stylish, streamlined and secure. It is highly engineered with over 120 different processes in each letterplate, setting it apart from anything else currently on the market.

TS008 has come in to effect that sets the advanced security requirements of letterplates. The updated door standard PAS 24:2016, now requires that a door fitted with a letterplate has to have a letterplate that is tested to and meets the requirements of TS008. As well as covering key fishing, TS008 also covers preventing being able to unlock the door through the letterplate, whilst also allowing postal items to pass freely through it.

THE SOTERIAN

certifire

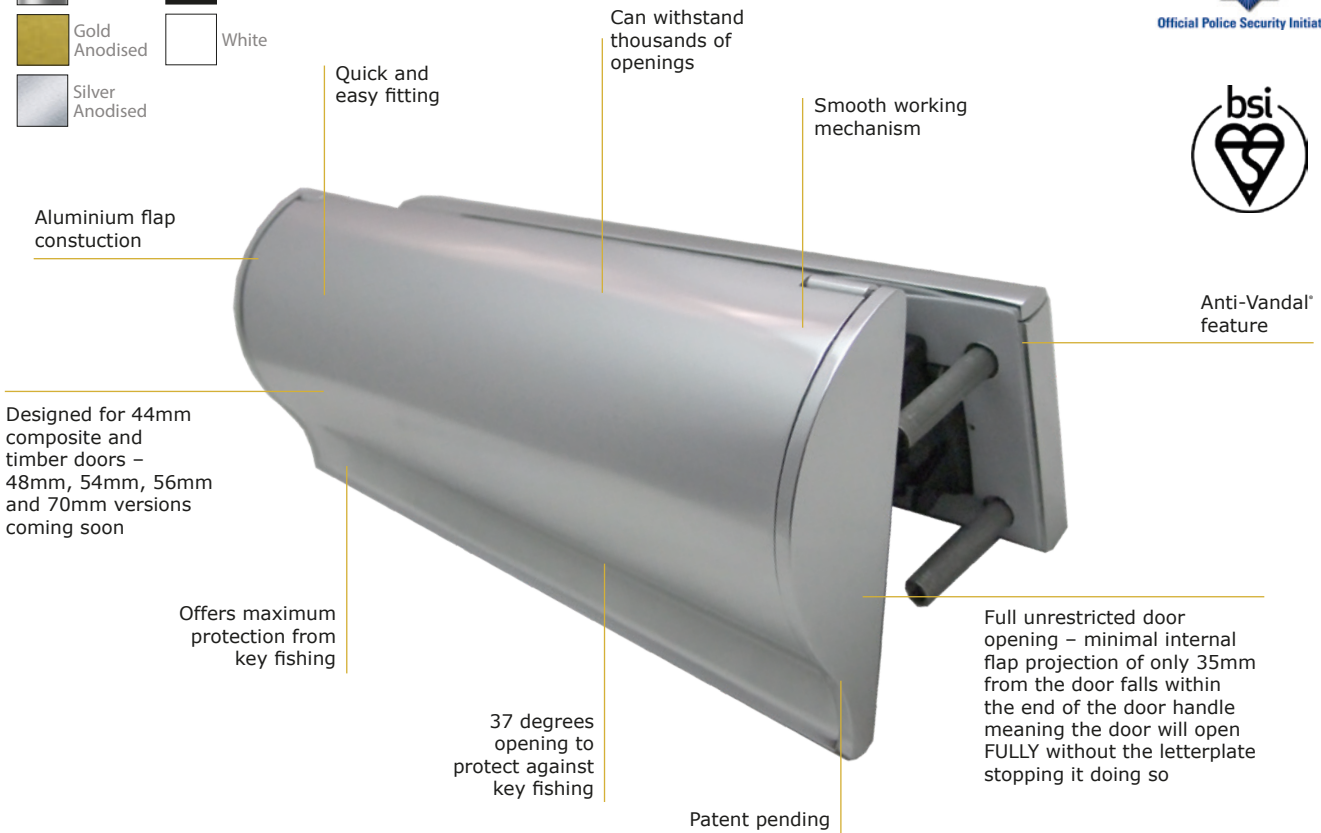

Finishes	Material Construction	Coating Guarantee	Internal Frame Code	External Frame Code
Chrome	Zamak	5 Years Inland	TS008-INTERNAL-CHROME	TS008-EXTERNAL-CHROME
Gold Anodised	Aluminium	5 Years Inland	TS008-INTERNAL-GOLD	TS008-EXTERNAL-GOLD
Silver Anodised	Aluminium	5 Years Inland	TS008-INTERNAL-SILVER	TS008-EXTERNAL-SILVER
Polished Silver	Aluminium	5 Years Inland	TS008-INTERNAL-PS	TS008-EXTERNAL-PS
Black	Aluminium	5 Years Inland	TS008-INTERNAL-BLACK	TS008-EXTERNAL-BLACK
White	Aluminium	5 Years Inland	TS008-INTERNAL-WHITE	TS008-EXTERNAL-WHITE

THE SOTERIAN TS008 SLIM LETTERPLATE

The Door & Hardware Federation (DHF) TS008: 2015 sets the advanced security requirements of letterplates. The updated door standard PAS 24:2016, now requires that a door fitted with a letterplate has to have a letterplate that is tested to and meets the requirements of TS008: 2015. As well as covering key fishing, TS008 also covers preventing being able to unlock the door through the letterplate, whilst also allowing postal items to pass freely through it.



CERTIFIRE APPROVED

The Soterian Slim TS008 letterplate has achieved Certifire approval from Warringtonfire Testing & Certification Limited. The letterplate is approved for use with FD30 timber doorsets.

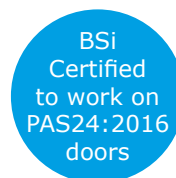
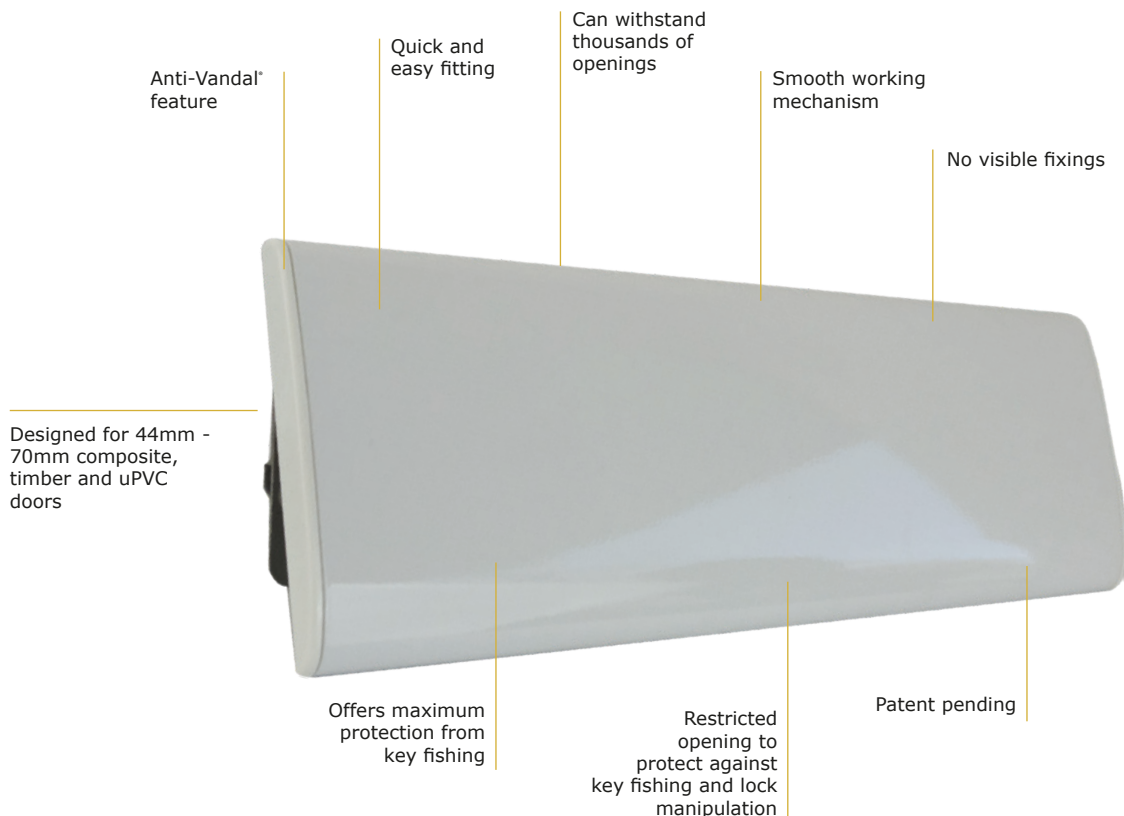

MIX AND MATCH SOLUTION

Our revolutionary mix and match solution gives you the freedom to choose what finish you want for the internal and external frame. Whether it is a black inner frame with a white outer frame, or a traditional gold inner flap and gold outer flap – the choice is yours! Choose from 6 different finishes chrome, gold anodised, silver anodised, polished silver, black and white.

Full unrestricted door opening – minimal internal flap projection of only 35mm from the door falls within the end of the door handle meaning the door will open FULLY without the letterplate stopping it doing so



Distance Between Screw Holes	277mm
Letterplate Length	305mm
Letterplate Height	58mm
Frame Material	Aluminium
Cavity Hole Size	259mm x 48mm

Finishes	Internal Frame Code*	External Frame Code	Material Construction	Coating Guarantee
Satin Silver	TS008-INTERNAL-SILVER	TS008-EXTERNAL-PS	Aluminium	5 Years Inland
Satin Chrome	TS008-INTERNAL-SATINCHROME	-	Aluminium	5 Years Inland
Chrome	TS008-INTERNAL-CHROME	TS008-EXTERNAL-CHROME**	Aluminium	5 Years Inland
Black	TS008-INTERNAL-BLACK	TS008-EXTERNAL-BLACK	Aluminium	5 Years Inland
White	TS008-INTERNAL-WHITE	TS008-EXTERNAL-WHITE	Aluminium	5 Years Inland

* Internal use only

** For use on internal apartment flat entrance doors only

FIREMONGERY®

Compliance made easy

TS008 FIRE RESISTANT LETTERPLATE

The Salamander® TS008 Soterian 250mm 12 inch fire resistant letterplate comes with both an external and internal flap to protect your customer's homes, and is available in 40-80mm depth for composite and wooden doors. It is the ultimate TS008 certified letterplate, made to protect and perfect your door. Independently tested by Warringtonfire Testing & Certification Ltd, the letterplate is certified for FD30 and FD60 timber doorsets.

Our revolutionary mix and match solution gives you the freedom to choose what finish you want for the internal and external frame. Whether it is a black inner frame with a white outer frame, or a traditional gold inner flap and gold outer flap – the choice is yours!

THE
SOTERIAN



-  Gold Anodised
-  Silver Anodised
-  Polished Silver
-  Black
-  White



certifire

Soterian TS008 FD60 Specification

Finishes	Material Construction	Coating Guarantee	Internal Frame Code	External Frame Code
Gold Anodised	Aluminium	5 Years Inland	TS008-INTERNAL-GOLD-FD60	TS008-EXTERNAL-GOLD
Silver Anodised	Aluminium	5 Years Inland	TS008-INTERNAL-SILVER-FD60	TS008-EXTERNAL-SILVER
Polished Silver	Aluminium	5 Years Inland	TS008-INTERNAL-PS-FD60	TS008-EXTERNAL-PS
Black	Aluminium	5 Years Inland	TS008-INTERNAL-BLACK-FD60	TS008-EXTERNAL-BLACK
White	Aluminium	5 Years Inland	TS008-INTERNAL-WHITE-FD60	TS008-EXTERNAL-WHITE



Soterian TS008 FD30 Specification

Finishes	Material Construction	Coating Guarantee	Internal Frame Code	External Frame Code
Gold Anodised	Aluminium	5 Years Inland	TS008-INTERNAL-GOLD-FD30	TS008-EXTERNAL-GOLD
Silver Anodised	Aluminium	5 Years Inland	TS008-INTERNAL-SILVER-FD30	TS008-EXTERNAL-SILVER
Polished Silver	Aluminium	5 Years Inland	TS008-INTERNAL-PS-FD30	TS008-EXTERNAL-PS
Black	Aluminium	5 Years Inland	TS008-INTERNAL-BLACK-FD30	TS008-EXTERNAL-BLACK
White	Aluminium	5 Years Inland	TS008-INTERNAL-WHITE-FD30	TS008-EXTERNAL-WHITE

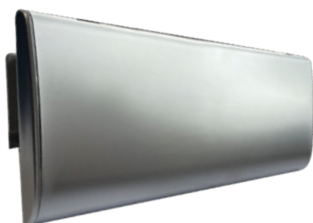

certifire

Soterian Slim TS008 FD30 Specification for Timber Doors:

Finishes	Material Construction	Coating Guarantee	Internal Frame Code*	External Frame Code
Silver	Aluminium & SSS	5 Years Inland	TS008-SLIM-INTERNAL-SILVER-CERTIFIRE(V)-FD30	TS008-EXTERNAL-SILVER
Satin Chrome	Aluminium & SSS	5 Years Inland	TS008-SLIM-INTERNAL-SATINCHROME-CERTIFIRE(V)-FD30	TS008-EXTERNAL-SILVER
PVD Gold	Aluminium & SSS	5 Years Inland	TS008-SLIM-INTERNAL-PVDG-CERTIFIRE(V)-FD30	TS008-EXTERNAL-PVDG
Chrome	Aluminium & SSS	5 Years Inland	TS008-SLIM-INTERNAL-CHROME-CERTIFIRE(V)-FD30	TS008-EXTERNAL-CHROME**
White	Aluminium & SSS	5 Years Inland	TS008-SLIM-INTERNAL-WHITE-CERTIFIRE(V)-FD30	TS008-EXTERNAL-WHITE

FIREMONGERY®

Compliance made easy



ALL STAINLESS STEEL FIRE RESISTANT

The All Stainless Steel letterplate is lined with special intumescent material which expands to 50 times its size, blocking the hole in the cavity and preventing smoke coming through the cavity. The All Stainless are specifically designed for areas which are within a 25 mile radius of the coast, or within 5 miles of highly populated industrial areas.

- Uses special heat absorbers to stop hot screws melting the plastic
- Intumescent activated at 5 degrees lower than most in the market
- Designed for 40-80mm thick composite and wooden doors
- Conforms to many standards and testing requirements including BS EN 1303:2005

Finish	Material Construction	Coating Guarantee	Product Code
PVD Gold	Stainless Steel	LIFETIME	FMSS1248PVDG-HD-FR-NANOCOAST
Mirror Polished	Stainless Steel	LIFETIME	FMSS1248MPSS-HD-FR-NANOCOAST
Satin Stainless	Stainless Steel	LIFETIME	FMSS1248SSS-HD-FR-NANOCOAST



ALL ALUMINIUM FIRE RESISTANT

The All Aluminium letterplate is lined with special intumescent material which expands to 50 times its size, blocking the hole in the cavity and preventing smoke coming through the cavity. The Fire Resistant Anti-Vandal 300mm all aluminium 12 inch letterplate comes with both an external and internal flap to protect your customer's homes, and is available in 40-80mm depths for composite and wooden doors.

- Uses special heat absorbers to stop hot screws melting the plastic
- Intumescent activated at 5 degrees lower than most in the market
- Designed for 40-80mm thick composite and wooden doors
- Conforms to many standards and testing requirements including BS EN 1303:2005

Finishes	Material Construction	Coating Guarantee	Product Code
Gold Anodised	Aluminium	10 Years Colour Fast	FMG1248G-FR
Silver Anodised	Aluminium	10 Years Colour Fast	FMS1248S-FR
Black	Aluminium	10 Years Colour Fast	FMB1248BALU-FR
White	Aluminium	10 Years Colour Fast	FMW1248WALU-FR
Polished Silver	Aluminium	10 Years Colour Fast	FMPS1248PS-FR



FRAMEMASTER FIRE RESISTANT

The Framemaster letterplate is lined with special intumescent material which expands to 50 times its size, blocking the hole in the cavity and preventing smoke coming through the cavity. The Framemaster letterplate is compliant to BS EN1634-3:2004 smoke leakage regulations.

- Uses special heat absorbers to stop hot screws melting the plastic
- Intumescent activated at 5 degrees lower than most in the market
- Designed for 40-80mm thick composite and wooden doors
- 180 degree opening flap means the flap will not snap off when opened too far

Finish	Material Construction	Coating Guarantee	Product Code
Gold Anodised	Aluminium	5 Years Inland	FMB1248G-FR
Silver Anodised	Aluminium	5 Years Inland	FMB1248SA-FR
Black Powder Coat	Aluminium	5 Years Inland	FMB1248B-FR
White Powder Coat	Aluminium	5 Years Inland	FMB1248W-FR
PVD Gold	Stainless Steel	LIFETIME	FMB1248PVDG-FR-NANOCOAST
Mirror Polished	Stainless Steel	LIFETIME	FMB1248MPSS-FR-NANOCOAST
Satin Stainless	Stainless Steel	LIFETIME	FMB1248SSS-FR-NANOCOAST

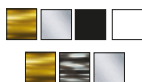

ALL STAINLESS STEEL LETTERPLATE

These heavy duty all stainless steel letterplates are sturdier and heavier than any other letterplate, offering a better quality product and making them more resistant.

- Anti-Vandal feature prevents vandals from placing unwanted items into the cavity
- 180 degree opening flap means the flap will not snap off when opened too far
- Conforms to many standards and testing requirements including BS EN 1303:2005
- Ultra-flexible springs can withstand the letterbox flap opening thousands of times without breaking
- Internal water seal prevents water getting into the door or panel, and stops letters getting wet

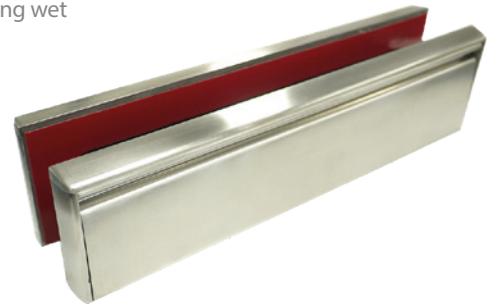
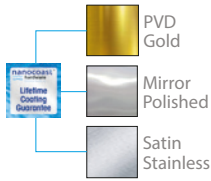

Finish	Material Construction	Coating Guarantee	Standard Code	Heavy Duty Code
PVD Gold	Stainless Steel	LIFETIME	FMSS1248PVDG-NANOCOAST	FMSS1248PVDG-HD-NANOCOAST
Mirror Polished	Stainless Steel	LIFETIME	FMSS1248MPSS-NANOCOAST	FMSS1248MPSS-HD-NANOCOAST
Satin Stainless	Stainless Steel	LIFETIME	FMSS1248SSS-NANOCOAST	FMSS1248SSS-HD-NANOCOAST

ALL ALUMINIUM LETTERPLATE

Each letterplate is made of high-grade material and has outward facing brushes (Anti-Vandal feature). The cavity hole dimension to drill into your doors in order to fit the all aluminium 12 inch letterplate is 257mm x 39.75mm.

- Made from aluminium
- Comes with a 10 year colour fast guarantee against colour fading in the sun
- Designed for 40-80mm thick composite and wooden doors
- Conforms to many standards and testing requirements including BS EN 1303:2005
- 180 degree opening flap means the flap will not snap off when opened too far



Finish	Material Construction	Coating Guarantee	Product Code
Gold Anodised	Aluminium	10 Years Colour Fast	FMG1248G
Silver Anodised	Aluminium	10 Years Colour Fast	FMG1248S
Black Powder Coat	Aluminium	10 Years Colour Fast	FMB1248BALU
White Powder Coat	Aluminium	10 Years Colour Fast	FMW1248WALU
Polished Silver	Aluminium	10 Years Colour Fast	FMPS1248PS

nanocoast®

FRAMEMASTER LETTERPLATE



The Framemaster 12 inch letterplate has many features not found on standard letterboxes, such as the trademarked Anti-Vandal facility. Each Anti-Vandal letterplate has outward facing brushes – a feature no other letterplate in the industry has!

- Comes in 2 sleeve thicknesses – 20-40mm for uPVC and 40-80mm for wooden and composite doors
- Revolutionary Patent pending self-aligning screw boss makes screwing the frames together easy
- Conforms to BS EN 1303:2005
- Ultra-flexible springs can withstand the letterbox flap opening thousands of times without breaking
- 180 degree opening flap means the flap will not snap off when opened too far



ANTI SNAP FLAP



ANTI VANDAL



ANTI SCRATCH



ANTI BURGLAR

Finish	Plastic Frame Colour	Flap Material Construction	Coating Guarantee	20-40mm	40-80mm
Mirror Polished	Black	Stainless Steel	LIFETIME	FMB1224MPSS-NANOCOAST	FMB1248PVDG-NANOCOAST
PVD Gold	Black	Stainless Steel	LIFETIME	FMB1224PVDG-NANOCOAST	FMB1248MPSS-NANOCOAST
Satin Stainless	Black	Stainless Steel	LIFETIME	FMB1224SSS-NANOCOAST	FMB1248SSS-NANOCOAST

FRAMEMASTER LETTERPLATE



- Flap made from aluminium
- Comes with a 5 year inland guarantee
- Designed for 20-40mm for uPVC and 40-80mm for wooden and composite doors
- Conforms to many standards and testing requirements including BS EN 1303:2005
- 180 degree opening flap means the flap will not snap off when opened too far

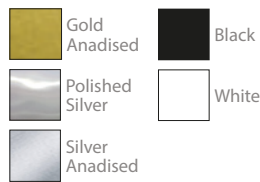

ANTI SNAP FLAP



ANTI VANDAL



ANTI SCRATCH



ANTI BURGLAR

Finish	Plastic Frame Colour	Flap Material Construction	Coating Guarantee	20-40mm	40-80mm
Gold Anodised	Black	Aluminium	5 Years Inland	FMB1224G	FMB1248G
Silver Anodised	Black	Aluminium	5 Years Inland	FMB1224SA	FMB1248SA
Black Powder Coat	Black	Aluminium	5 Years Inland	FMB1224B	FMB1248B
White Powder Coat	Black	Aluminium	5 Years Inland	FMB1224W	FMB1248W
White Powder Coat	White	Aluminium	5 Years Inland	FMW1224W	FMW1248W

PETITEMASTER 10 INCH LETTERPLATE



Finish	Plastic Frame Colour	Flap Material Construction	Coating Guarantee	20-40mm Door Opening	40-80mm Door Opening
Gold Anodised	Black	Aluminium	5 Years Inland	PMB1024G	PMB1048G
Silver Anodised	Black	Aluminium	5 Years Inland	PMB1024SA	PMB1048SA
Black Powder Coat	Black	Aluminium	5 Years Inland	PMB1024B	PMB1048B
White Powder Coat	Black	Aluminium	5 Years Inland	PMB1024W	PMB1048W
PVD Gold	Black	Stainless Steel	LIFETIME	PMB1024PVDG -NANOCOAST	PMB1048PVDG -NANOCOAST
Mirror Polished	Black	Stainless Steel	LIFETIME	PMB1024MPSS -NANOCOAST	PMB1048MPSS -NANOCOAST
White Powder Coat	White	Aluminium	5 Years Inland	PMW1024W	PMW1048W



SLIMLINE 12 INCH LETTERPLATE



Finish	Plastic Frame Colour	Flap Material Construction	Coating Guarantee	40-80mm Door Opening
Gold Anodised	Black	Aluminium	5 Years Inland	SLB1248G
Silver Anodised	Black	Aluminium	5 Years Inland	SLB1248S
Black Powder Coat	Black	Aluminium	5 Years Inland	SLB1248B
White Powder Coat	Black	Aluminium	5 Years Inland	SLB1248W
PVD Gold	Black	Stainless Steel	LIFETIME	SLB1248PVDG -NANOCOAST
Mirror Polished	Black	Stainless Steel	LIFETIME	SLB1248MPSS -NANOCOAST



IPLATE 12 INCH LETTERPLATE



Finish	Flap Material Construction	Coating Guarantee	40-80mm Door Opening
Gold Anodised	Aluminium	10 Years Colour Fast	IPLATEGA
Silver Anodised	Aluminium	10 Years Colour Fast	IPLATESA
Black Powder Coat	Aluminium	10 Years Colour Fast	IPLATEB
White Powder Coat	Aluminium	10 Years Colour Fast	IPLATEW
Mirror Polished	Stainless Steel	LIFETIME	IPLATEMPSS-NANOCOAST
PVD Gold	Stainless Steel	LIFETIME	IPLATEPVDG-NANOCOAST
Satin Stainless	Stainless Steel	LIFETIME	IPLATESSS-NANOCOAST



DOORMASTER 12 INCH LETTERPLATE



Finish	Plastic Frame Colour	Flap Material Construction	Coating Guarantee	20-40mm Door Opening	40-80mm Door Opening
Gold Anodised	Black	Aluminium	5 Years Inland	DMB1224G	DMB1248G
Silver Anodised	Black	Aluminium	5 Years Inland	DMB1224SA	DMB1248S
Black Powder Coat	Black	Aluminium	5 Years Inland	DMB1224B	DMB1248B
White Powder Coat	Black	Aluminium	5 Years Inland	DMB1224W	DMB1248W
Polished Silver	Black	Aluminium	5 Years Inland	DMB1224PS	DMB1248PS

COLOURED DOORMASTER 12 INCH LETTERPLATE



Finish	Plastic Frame Colour	Flap Material Construction	Coating Guarantee	40-80mm Door Opening
Gold Anodised	Silver	Aluminium	5 Years Inland	DMS1248S
Silver Anodised	Gold	Aluminium	5 Years Inland	DMS1248G

DOORMASTER 10 INCH LETTERPLATE



Finish	Plastic Frame Colour	Flap Material Construction	Coating Guarantee	40-80mm Door Opening
Gold Anodised	Black	Aluminium	5 Years Inland	DMB1048G
Silver Anodised	Black	Aluminium	5 Years Inland	DMB1048S
Black Powder Coat	Black	Aluminium	5 Years Inland	DMB1048B
White Powder Coat	Black	Aluminium	5 Years Inland	DMB1048W
Polished Silver	Black	Aluminium	5 Years Inland	DMB1048PS



BLACK IRON PLAIN LETTERPLATE



Finish	Material Construction	Coating Guarantee	Code
Black	Iron	5 Years Inland	LPPLAINBLK-IRON

BLACK IRON INTERNAL LETTERPLATE



Finish	Material Construction	Coating Guarantee	Code
Black	Iron	5 Years Inland	INTTIDYBLK-IRON

BLACK IRON INTERNAL LETTERPLATE



Finish	Material Construction	Coating Guarantee	Code
Black	Iron	5 Years Inland	LPFDLBLK-IRON



DUO STAINLESS STEEL DOOR HANDLE

The Nanocoast® DUO door handle has a 243mm long backplate, and is aimed at the fabricator who wants to offer a high quality designed door handle. The DUO door handle has a tube shaped handle, which gives a very comfortable grip when operating.

As the DUO handle suits all needs – working as an attractive high-quality lever handle whilst being DDA compliant – it allows fabricators to carry just one handle in stock to satisfy a number of different applications.

The DUO door handle has a lever that is curved to the door, making it compliant to DDA (Disability Discrimination Act) regulations, making it ideal for applications where aesthetics and compliance are key. As the DUO handle is not BSI Kitemarked, we recommend fitting the Kinetica 3* Kitemarked Euro Cylinder with it in order to achieve a 3* Kitemark status for PAS 24 doors.

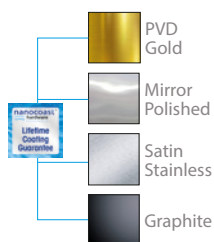

Finish	243mm Backplate	Material	Coating Guarantee
PVD Gold	DH243-DUO-PVDG-NANOCOAST	Stainless Steel	LIFETIME
Mirror Polished	DH243-DUO-MPSS-NANOCOAST	Stainless Steel	LIFETIME
Satin Stainless	DH243-DUO-SSS-NANOCOAST	Stainless Steel	LIFETIME
Graphite *	DH243-DUO-GRAPHITE-NANOCOAST	Stainless Steel	LIFETIME

*Made to order

HIGH SECURITY STAINLESS STEEL DOOR HANDLE

The Nanocoast® High Security Stainless Steel front door handle has a 243mm long backplate. Both the internal and external part of the handle are manufactured from high quality 316 grade stainless steel offering a high-quality and corrosion resistant front door handle.

These door handles are part of the Nanocoast® range of products, specifically designed for areas which are within a 25 mile radius of the coast, or within 5 miles of highly populated industrial areas. Each front door handle has been salt spray tested to ASTM B117 for 2,000 hours and comes with an industry first LIFETIME coating guarantee, as the products will not pit, rust or corrode no matter what environments you put them in!

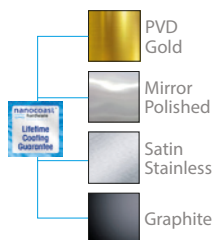

Finish	243mm Backplate	Material	Coating Guarantee
PVD Gold	HS243PVDG-NANOCOAST	Stainless Steel	LIFETIME
Mirror Polished	HS243MPSS-NANOCOAST	Stainless Steel	LIFETIME
Satin Stainless	HS243SSS-NANOCOAST	Stainless Steel	LIFETIME
Graphite*	HS243GRAPHITE-NANOCOAST	Stainless Steel	LIFETIME

*Made to order

DOOR HANDLES

nanocoast®



SPLIT SPINDLE

DUO SPLIT SPINDLE

- Attractive high-quality lever handle
- Made from high grade stainless steel
- DDA compliant
- Lifetime coating guarantee



Finish	243mm Backplate	Material	Coating Guarantee
PVD Gold	DH243PVDG-DUO-SPLIT-NANOCOAST	Stainless Steel	LIFETIME
Mirror Polished	DH243MPSS-DUO-SPLIT-NANOCOAST	Stainless Steel	LIFETIME
Satin Stainless	DH243SSS-DUO-SPLIT-NANOCOAST	Stainless Steel	LIFETIME
Graphite *	DH243GRAPHITE-DUO-SPLIT-NANOCOAST	Stainless Steel	LIFETIME

*Made to order



STANDARD SPLIT SPINDLE

- Made from high grade stainless steel
- 243mm long backplate
- Lifetime coating guarantee



Finish	243mm Backplate	Material	Coating Guarantee
Mirror Polished	DH243MPSS-SPLIT-NANOCOAST-OLDSTYLE	Stainless Steel	LIFETIME
Satin Stainless	DH243SSS-SPLIT-NANOCOAST-OLDSTYLE	Stainless Steel	LIFETIME



STANDARD DOOR HANDLES

STANDARD DOOR HANDLE



Finish	243mm Backplate	Material	Coating Guarantee
PVD Gold	DH243PVDG-DUO-NANOCOAST	Stainless Steel	LIFETIME
Mirror Polished	DH243MPSS-DUO-NANOCOAST	Stainless Steel	LIFETIME
Satin Stainless	DH243SSS-DUO-NANOCOAST	Stainless Steel	LIFETIME
Graphite *	DH243-DUO-GRAPHITE-NANOCOAST	Stainless Steel	LIFETIME

*Made to order



STANDARD DDA DOOR HANDLE

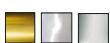

Finish	243mm Backplate	Material	Coating Guarantee
PVD Gold	DH243PVDG-DDA-NANOCOAST	Stainless Steel	LIFETIME
Mirror Polished	DH243MPSS-DDA-NANOCOAST	Stainless Steel	LIFETIME
Satin Stainless	DH243SSS-DDA-NANOCOAST	Stainless Steel	LIFETIME



SIGNATURE RANGE

The DOORMASTER® Signature range standard security aluminium door handles are aimed at the fabricator who wants to offer a high quality designed door handle. Each door handle is made from aluminium and has a 5 year coating guarantee. Contemporary and modern in appearance, the standard aluminium door handle has

been cleverly designed to offer a very comfortable grip when operating. It is recommended to fit a Kinetica 3* Kitemarked euro cylinder with the door handle in order to give the best security and to achieve a 3 star Kitemark status for PAS 24 doors.

243MM ALUMINIUM DOOR HANDLE



Finish	243mm Backplate	Material Construction	Coating Guarantee
Black	DH243B-SIGNATURE	Aluminium	5 years
White	DH243W-SIGNATURE	Aluminium	5 years
Silver	DH243S-SIGNATURE	Aluminium	5 years
Anthracite Grey	DH243SGREY-SIGNATURE	Aluminium	5 years



219MM ALUMINIUM DOOR HANDLE



Finish	243mm Backplate	Material Construction	Coating Guarantee
Black	DH219B-SIGNATURE	Aluminium	5 years
White	DH219W-SIGNATURE	Aluminium	5 years



LEVER PAD DOOR HANDLE

Designed for comfort and ease of operation, the DOORMASTER® Pad door handle has a 243mm long backplate.

Each front door handle has a pad shaped external handle. Handles are non-handed and can be used as either a left or right handed, allowing it to fit a range of profiles.

It is recommended to fit a Kinetica 3* Kitemarked euro cylinder with the door handle in order to give the best security and to achieve a 3 star Kitemark status for PAS 24 doors.



Finish	243mm Backplate	Material Construction	Coating Guarantee
White	DH243-LPW	Aluminum	5 years



219MM ALUMINIUM DOOR HANDLE



Finish	Material Construction	Coating Guarantee	219mm Code	243mm Code
Black	Iron	5 Years Inland	DRHANDBLK-219-IRON	DRHANDBLK-243-IRON



DOOR HANDLES ON ROSE





Calla



Ruby



Fern



Falcon



Ava



Truro



Lyra



Ventura



Enterprise



Nevis



Jade



K2



MATCHING ACCESSORY RANGE AVAILABLE

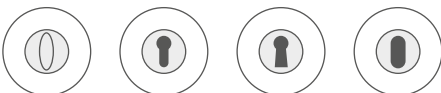

Polished Chrome



Satin Chrome



Gun Metal Grey



Matt Black

6" VICTORIAN URN UNIVERSAL DOOR KNOCKERS

The 6 Inch Victorian Urn Hidden Fix Door Knocker has a super-strong, waterproof adhesive covering, so fixing a door knocker has never been so simple.

- Available with or without a hole for door viewers
- Patented hidden fix mechanism
- Waterproof seal stops rusting behind the door knocker
- Easy to fix and easy to remove
- Come with a LIFETIME coating guarantee

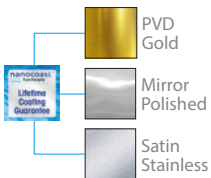

Finish	Material Construction	Coating Guarantee	Solid Code	Solid Code
PVD Gold	Stainless Steel	LIFETIME	V6PVDGHF-NANOCOAST	V6PVDGHHF-NANOCOAST
Mirror Polished	Stainless Steel	LIFETIME	V6MPSSHf-NANOCOAST	V6MPSSHf-NANOCOAST
Satin Stainless	Stainless Steel	LIFETIME	V6SSSHf-NANOCOAST	V6SSSHf-NANOCOAST

8" SLIM UNIVERSAL DOOR KNOCKERS

The 8 Inch Victorian Slimline Urn Hidden Fix Door Knocker has a super-strong, waterproof adhesive covering, so fixing a door knocker has never been so simple.

- Patented hidden fix mechanism
- Waterproof seal stops rusting behind the door knocker
- Manufactured from high grade stainless steel

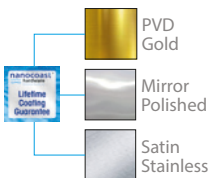

Finish	Material Construction	Coating Guarantee	Solid Code	Solid Code
PVD Gold	Stainless Steel	LIFETIME	VSLPVDGHF-NANOCOAST	VSLPVDGHHF-NANOCOAST
Mirror Polished	Stainless Steel	LIFETIME	VSLMPSSHf-NANOCOAST	VSLMPSSHf-NANOCOAST
Satin Stainless	Stainless Steel	LIFETIME	VSLSSSHf-NANOCOAST	VSLSSSHf-NANOCOAST

8" SLIM DOOR KNOCKERS

With its slim vertical profile, the 8 Inch Slimline Victorian Urn is ideal for all metal doors. The clever universal fixing system brings together bolt-fix and self-adhesive systems into one product, helping you save stock space.

- Waterproof seal stops rusting behind the door knocker
- Manufactured from aluminium



Finish	Material Construction	Coating Guarantee	Solid Code	Solid Code
Silver Anodised	Aluminium	10 Years Colour Fast	VLSACH	VLSACH



DOOR KNOCKERS

5" VICTORIAN URN BOLT FIX



Finish	Material Construction	Coating Guarantee	Solid Code
Polished Brass	Brass	5 Years Inland	V5BR
Black Powder Coat	Brass	5 Years Inland	V5BL

Fitted with easy-to-cut flexi nylon bolts

Comes with colour matched nuts and washer

Ideal for smaller sized doors or doors with vertical mullions

Can fit door thicknesses of up to 75mm

8" VICTORIAN URN BOLT FIX



Finish	Material Construction	Coating Guarantee	Solid Code	With Hole
Polished Brass	Brass	5 Years Inland	V8BR	V8BRH
Polished Chrome	Brass	5 Years Inland	V8CH	V8CHH
Black Powder Coat	Brass	5 Years Inland	V8BL	V8BLH
White Powder Coat	Brass	5 Years Inland	V8WH	V8WHH

Fitted with easy-to-cut flexi nylon bolts

Comes with colour matched nuts and washer

Ideal for composite and wooden doors with a larger door face

Can fit door thicknesses of up to 75mm

8" SLIMLINE VICTORIAN URN BOLT FIX



Finish	Material Construction	Coating Guarantee	Solid Code	With Hole
Black Powder Coat	Brass	5 Years Inland	VSLBL	VSLBLH
White Powder Coat	Brass	5 Years Inland	VSLWH	VSLWHH
Black	Zamak	5 Years Inland	VSLBL-SIGNATURE	VSLBLH-SIGNATURE
White	Zamak	5 Years Inland	VSLWH-SIGNATURE	VSLWHH-SIGNATURE
PVD Gold	Zamak	5 Years Inland	VSLPVDG-SIGNATURE	VSLPVDGH-SIGNATURE
Satin Chrome	Zamak	5 Years Inland	VSLSC-SIGNATURE	VSLSCH-SIGNATURE
Polished Chrome	Zamak	5 Years Inland	VSLCH-SIGNATURE	VSLCHH-SIGNATURE

Fitted with easy-to-cut flexi nylon bolts

Comes with colour matched nuts and washer

Ideal for doors with planks, panels or mouldings

Can fit door thicknesses of up to 75mm

SIGNATURE VICTORIA SCROLL



Finish	Material Construction	Coating Guarantee	Code
Polished Brass	Brass	5 Years Inland	SVSBR
Polished Chrome	Brass	5 Years Inland	SVSCH
Black Powder Coat	Brass	5 Years Inland	SVSBL
White Powder Coat	Brass	5 Years Inland	SVSWH

OVAL GEORGIAN SCROLL



Finish	Material Construction	Coating Guarantee	Code
Polished Brass	Brass	5 Years Inland	SCBRO
Polished Chrome	Brass	5 Years Inland	SCCHO
Black Powder Coat	Brass	5 Years Inland	SCBLO
White Powder Coat	Brass	5 Years Inland	SCWHO

MODERN OVAL



Finish	Material Construction	Coating Guarantee	Code
Polished Brass	Brass	5 Years Inland	SMOBR
Polished Chrome	Brass	5 Years Inland	SMOCH
Black Powder Coat	Brass	5 Years Inland	SMOB

PONYTAIL



Finish	Material Construction	Coating Guarantee	Code
Polished Brass	Brass	5 Years Inland	PTBR
Polished Chrome	Brass	5 Years Inland	PTCH
Black Powder Coat	Brass	5 Years Inland	PTBL
White Powder Coat	Brass	5 Years Inland	PTWH
Silver Powder Coat	Brass	5 Years Inland	PTSA
PVD Gold	Zamak	5 Years Inland	PTPVDG-SIGNATURE

LARGE TRADITIONAL DOCTOR



Finish	Material Construction	Coating Guarantee	Code
Polished Brass	Brass	5 Years Inland	DOCTOR-LARGE BR
Satin Chrome	Brass	5 Years Inland	DOCTOR-LARGE SC
PVD Gold	Brass	5 Year Colour fast	DOCTOR-LARGE PVDG
Polished Chrome	Brass	5 Year Colour fast	DOCTOR-LARGE CH

6" TRADITIONAL DOCTOR



Finish	Material Construction	Coating Guarantee	Code
Polished Brass	Brass	5 Years Inland	DOCTOR BR
Polished Chrome	Brass	5 Years Inland	DOCTOR CH



LARGE LIONS HEAD



Finish	Material Construction	Coating Guarantee	Code
Polished Brass	Brass	5 Years Inland	LH6BR
Polished Chrome	Brass	5 Years Inland	LH6CH
Black Powder Coat	Brass	5 Years Inland	LH6BL
White Powder Coat	Brass	5 Years Inland	LH6WH

SMALL LIONS HEAD



Finish	Material Construction	Coating Guarantee	Code
Polished Brass	Brass	5 Years Inland	LH6BR
Polished Chrome	Brass	5 Years Inland	LH6CH
Black Powder Coat	Brass	5 Years Inland	LH6BL
White Powder Coat	Brass	5 Years Inland	LH6WH

6" ROUND LION'S HEAD



Finish	Material Construction	Coating Guarantee	Code
Polished Brass	Brass	5 Years Inland	LHRBR
Polished Chrome	Brass	5 Years Inland	LHRCH
Black Powder Coat	Brass	5 Years Inland	LHRBL
White Powder Coat	Brass	5 Years Inland	LHRWH

9" ROUND LION'S HEAD



Finish	Material Construction	Coating Guarantee	Code
Polished Brass	Brass	5 Years Inland	LH9RBR

6" BLACK IRON VICTORIAN URN



Finish	Material Construction	Coating Guarantee	Code
Black	Iron	5 Years Inland	V6BLK-IRON

ROUND BLACK IRON



Finish	Material Construction	Coating Guarantee	Code
Black	Iron	5 Years Inland	ROUNDKNOCKER-BLK-IRON

6" BLACK IRON LION'S HEAD



Finish	Material Construction	Coating Guarantee	Code
Black	Iron	5 Years Inland	LH6BLK-IRON

TWO PIECE BLACK IRON LION'S HEAD



Finish	Material Construction	Coating Guarantee	Code
Black	Iron	5 Years Inland	LHBLK-2PIECE-IRON

DOOR SECURITY

nanocoast®

3 INCH SELF ADHESIVE NUMERAL

- Classic Times Roman font
- Self-adhesive fixing
- Super strong waterproof covering stops water getting behind the numeral and prevents rusting
- Numerals can be removed if needed – with no damage to the door
- Can be fitted to any wall or surface
- Manufactured from high grade stainless steel
- LIFETIME coating guarantee

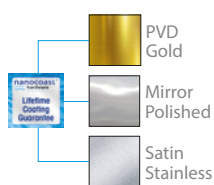

Finish	Material Construction	Coating Guarantee	Numbers 0-9	Letters A-C
PVD Gold	Stainless Steel	LIFETIME	0-9TRPVDGSA-NANOCOAST	A-CTRPVDGSA-NANOCOAST
Mirror Polished	Stainless Steel	LIFETIME	0-9TRMPSSSA-NANOCOAST	A-CTRMPSSSA-NANOCOAST
Satin Stainless	Stainless Steel	LIFETIME	0-9TRSSSSA-NANOCOAST	A-CTRSSSSA-NANOCOAST

3 INCH SELF ADHESIVE NUMERAL

- Classic Times Roman font
- Self-adhesive fixing
- Super strong waterproof covering stops water getting behind the numerals and prevents rusting
- Numerals can be removed if needed – with no damage to the door
- Can be fitted to any wall or surface
- Manufactured from aluminium



Finish	Material Construction	Coating Guarantee	Numbers 0-9	Letters A-C	Letters D-H
Gold Anodised	Aluminium	10 Years Colour Fast	0-9TRGAC	A-CTRGAC	D-HTRGAC
Silver Anodised	Aluminium	10 Years Colour Fast	0-9TRSAC	A-CTRSAC	D-HTRSAC



DOOR NUMERALS

3 INCH SCREW FIX DOOR NUMERALS

- Classic Times Roman font
- Each numeral comes with 2 colour matching screws
- Easy to install
- Manufactured from high grade stainless steel
- LIFETIME coating guarantee

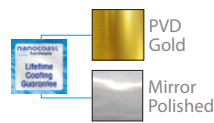

Finish	Material Construction	Coating Guarantee	Numbers 0-9	Letters A-C	Letters A-C
PVD Gold	Stainless Steel	LIFETIME	0-9TRPVDG	A-CTRPVDG	D-HTRPVDG
Mirror Polished	Stainless Steel	LIFETIME	0-9TRMPSS	A-CTRMPSS	D-HTRMPSS

3 INCH SCREW FIX THIN DOOR NUMERALS

- Classic Times Roman font
- Each numeral comes with 2 colour matching screws
- Easy to install
- Manufactured from high grade stainless steel
- LIFETIME coating guarantee



Finish	Material Construction	Coating Guarantee	Numbers 0-9	Letters A-C
PVD Gold	Stainless Steel	LIFETIME	0-9PVDG-NANOCOAST	A-DPVDG-NANOCOAST
Mirror Polished	Stainless Steel	LIFETIME	0-9MPSS-NANOCOAST	A-DMPSS-NANOCOAST
Satin Stainless	Stainless Steel	LIFETIME	0-9SSS-NANOCOAST	A-DSSS-NANOCOAST

4 INCH BLACK IRON FRONT DOOR NUMERALS

- Each numeral comes with 2 colour matching screws
- Easy to install
- Made from solid cast iron
- Black powder coated
- Ideal for cottages and period properties



Finish	Material Construction	Coating Guarantee	Numbers 0-9	Letters A-C
Black	Iron	5 Years Inland	0-9BLK-4-IRON	A-CBLK-4-IRON

3 INCH SCREW FIX DOOR NUMERALS

- Classic Times Roman font
- Each numeral comes with 2 colour matching screws
- Easy to install



Finish	Material Construction	Coating Guarantee	Numbers 0-9	Lettersn A-C	Letters D-H
Polished Brass	Brass	5 Years Inland	0-9TRBR	A-CTRBR	D-ZTRBR
Black Powder Coat	Brass	5 Years Inland	0-9TRBL	A-CTRBL	N/A
Polished Chrome	Brass	5 Years Inland	0-9TRCH	A-CTRCH	0-9TRCH

3 INCH SIGNATURE SCREW FIX BEVELLED EDGE

- Classic Times Roman font
- Each numeral comes with 2 colour matching screws
- Easy to install
- Come with a 5 year inland coating guarantee



Finish	Material Construction	Coating Guarantee	Numbers 0-9	Lettersn A-C	Letters D-H
PVD Gold	Zamak	5 Years Inland	0-9TRPVDG-SIGNATURE	A-CTR PVDG-SIGNATURE	D-FTRPVDG-SIGNATURE
Polished Chrome	Zamak	5 Years Inland	0-9TRCH-SIGNATURE	A-CTRCH-SIGNATURE	D-FTRPVDG-SIGNATURE
Satin Chrome	Zamak	5 Years Inland	0-9TRSC-SIGNATURE	A-CTRSC-SIGNATURE	N/A

2 INCH SCREW FIX DOOR NUMERALS

- 2 inches in height
- Each numeral comes with 2 colour matching screws
- Easy to install
- Come with a 5 year inland coating guarantee

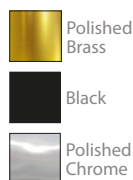

Finish	Material Construction	Coating Guarantee	Numbers 0-9	Lettersn A-C
Polished Brass	Brass	5 Years Inland	0-9BR2	A-CBR2
Black Powder Coat	Brass	5 Years Inland	0-9BL2	A-CBL2
Polished Chrome	Brass	5 Years Inland	0-9CH2	A-CCH2

DOOR SECURITY

nanocoast®

DOOR VIEWERS (SPYHOLES)

12MM WOODEN AND COMPOSITE (35-55MM)

- Secured by Design
- Comprises of 3 plastic lenses
- Tested to DHF TS002:2009
- Made from grade 316 stainless steel
- LIFETIME coating guarantee

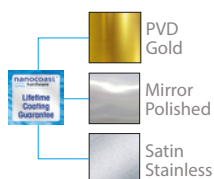

Finish	Material Construction	Material Construction	Product Code
PVD Gold	Stainless Steel	Stainless Steel	CILPVDG38-63-NANOCOAST
Mirror Polished	Stainless Steel	Stainless Steel	CILMPSS38-63-NANOCOAST
Satin Stainless	Stainless Steel	Stainless Steel	CILSSS38-63-NANOCOAST

12MM WIDE ANGLE (35-55MM)

- Secured by Design
- Comprises of 3 plastic lenses
- Tested to DHF TS002:2009
- Made from grade 316 stainless steel
- LIFETIME coating guarantee



Finish	Material Construction	Material Construction	Product Code
PVD Gold	Stainless Steel	Stainless Steel	CVPLPVDG-NANOCOAST
Mirror Polished	Stainless Steel	Stainless Steel	CVPLMPSS-NANOCOAST
Satin Stainless	Stainless Steel	Stainless Steel	CVPLSSS-NANOCOAST

12MM UPVC DOOR VIEWERS (20-35MM)



Finish	Material Construction	Coating Guarantee	Product Code
Polished Brass	Brass	5 Years Inland	CICBR
Polished Chrome	Brass	5 Years Inland	CICCH
White	Brass	5 Years Inland	CICWH
Black	Brass	5 Years Inland	CICBL
Gold Anodised	Aluminium	10 Years Colour Fast	CICGA
Silver Anodised	Aluminium	10 Years Colour Fast	CICSA



12MM LONG DOOR VIEWERS (55-75MM)



Finish	Material Construction	Coating Guarantee	Product Code
Polished Brass	Brass	5 Years Inland	SDV125575BR
Polished Chrome	Brass	5 Years Inland	SDV125575CH
White	Brass	5 Years Inland	SDV125575WH
Black	Brass	5 Years Inland	SDV125575BL



12MM WIDE ANGLE (35-55MM)



Finish	Material Construction	Coating Guarantee	Product Code
Polished Brass	Brass	5 Years Inland	CVPLBR
Polished Chrome	Brass	5 Years Inland	CVPLCH
White	Brass	5 Years Inland	CVPLWH
Black	Brass	5 Years Inland	CVPLBL
Gold Anodised	Aluminium	10 Years Colour Fast	CVPLGA
Silver Anodised	Aluminium	10 Years Colour Fast	CVPLSA

14MM WIDE ANGLE (35-55MM)



Finish	Material Construction	Coating Guarantee	Product Code
Polished Brass	Brass	5 Years Inland	CVPLBR14
Polished Chrome	Brass	5 Years Inland	CVPLCH14

14MM SUPER WIDE ANGLE (35-55MM)



Finish	Material Construction	Coating Guarantee	Product Code
Polished Brass	Brass	5 Years Inland	CVLP

PLASTIC ULTRA WIDE ANGLE SECURE TO VIEW™



Finish	Material Construction	Coating Guarantee	Product Code
Gold Plastic Frame	Plastic	5 Years Inland	STVG
Silver Plastic Frame	Plastic	5 Years Inland	STVS

METAL ULTRA WIDE ANGLE SECURE TO VIEW™



Finish	Material Construction	Coating Guarantee	Product Code
PVD Gold	Metal	5 Years Inland	STVSG

FIREMONGERY®

Compliance made easy

14MM FIRE RESISTANT (35-55MM)



Finish	Material Construction	Coating Guarantee	Product Code
Polished Brass	Brass	5 Years Inland	SWALFBR-FR
Polished Chrome	Brass	5 Years Inland	SWALFCH-FR
Satin Chrome	Brass	5 Years Inland	SWALFSC-FR

PLASTIC SECURE TO VIEW™ FIRE RESISTANT



Finish	Material Construction	Coating Guarantee	Product Code
Gold Plastic Frame	Plastic	5 Years Inland	STVG-FR
Silver Plastic Frame	Plastic	5 Years Inland	STVS-FR

DOOR SECURITY

HIGH SECURITY DOOR CHAIN

- Secured by Design
- TS003 approved
- Individually machine welded links makes the chains extra strong
- Exceeds breaking forces of over 2kN (200Kg)
- Suitable for every type and door size
- Tested in accordance with DHF TS003:2012 standards



Brass



Chrome



Satin Silver

Finish	Material Construction	Coating Guarantee	Product Code
Polished Brass	Steel	2 years	DCBN
Polished Chrome	Steel	2 years	DCCHN
Satin Silver	Steel	2 years	DCSSN

SLIDING DOOR CHAIN

- 1 hour fire rated
- Made from high grade steel
- Individually machine welded links makes the chains extra strong
- Exceeds breaking forces of over 2kN (200kg)

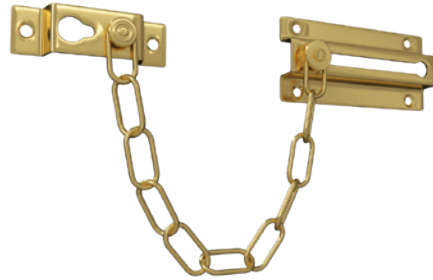

Brass



Chrome



Satin Silver

Finish	Material Construction	Coating Guarantee	Product Code
Polished Brass	Steel	2 years	DCB
Polished Chrome	Steel	2 years	DCCH
Satin Silver	Steel	2 years	DCSS

SLIDING DOOR CHAIN

- 1 hour fire rated
- Made from high grade steel
- Individually machine welded links makes the chains extra strong
- Exceeds breaking forces of over 2kN (200kg)

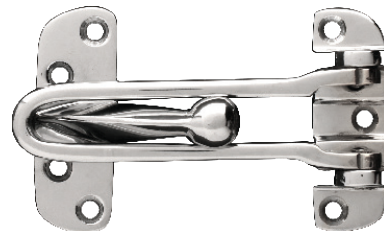

Brass



Chrome

Finish	Material Construction	Coating Guarantee	Product Code
Polished Brass	Steel	2 years	DRPB
Polished Chrome	Steel	2 years	DCH

DOOR STAY – 335MM IN LENGTH

- Independently tested to withstand gale force winds
- Easy to fit euro groove and bracket to frame
- Slider contains friction screws to hold the door open in mild wind conditions
- Can withstand thousands of openings
- Door stay made with a steel arm



Silver

Finish	Material Construction	Coating Guarantee	Product Code
Satin Silver	Steel	2 years	DOORSTAY-UNIVERSAL

DOOR CLOSER

- Size 3 architectural door closer
- Suits doors with 60kg maximum weight
- Suits doors with 2100mm x 950mm maximum size
- Universal application
- Two installation options
- Adjustable closing and latching speed
- Tested to 500,000 operating cycles
- CE tested to BS EN 1154 for 1121 CPD-AD-0169

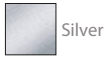

Silver

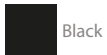

Black

Finish	Material Construction	Coating Guarantee	Product Code
Satin Silver	Steel	2 years	FDCS3
Black	Steel	2 years	FDCB3
Silver Bracket	Steel	2 years	FDCS3-A-BRACKET

3D ADJUSTABLE COMPOSITE DOOR HINGE

- Can be fitted on either the left hand or right hand side of a door
- Suitable for timber, composite and PVCu doors
- Made from aluminium
- Dimensions: 1000mm x 65mm
- 5 year guarantee



Finish	Material Construction	Coating Guarantee	Product Code
White	Aluminium	5 years	CDH-ADJUSTABLE-WHITE

2D COMPOSITE DOOR HINGE

- Suitable for timber and composite doors
- Dimensions 100mm x 82mm
- Tested to 80kg force
- Tested to EN1935:2002

Finish	Material Construction	Coating Guarantee	Product Code
PVD Gold	Stainless Steel	Lifetime	CDHPVDG-NANOCOAST
Mirror Polished	Stainless Steel	Lifetime	CDHMPSS-NANOCOAST
White Powder Coated	Q195 Steel	5 Years	CDHWH
Chrome	Q195 Steel	5 Years	CDHCH
Gold	Q195 Steel	5 Years	CDHG

FIREMONGERY®

Compliance made easy

FIRE RATED DOOR HINGES

- Tested to Certifire FD30 and FD60
- Tested in accordance with EN 1935:2002 standards
- Can be fitted on either the left hand or right hand side of a door
- Manufactured from high grade stainless steel
- Suitable for timber doors
- LIFETIME coating guarantee
- Dimensions 102mm x 71mm



Finish	Material Construction	Coating Guarantee	Product Code
Satin Stainless	Lifetime	Stainless Steel	HINGE-SS201-FIRE



*** Winner ***
**INSTALLER
AWARDS 2023**





UAP
LIMITED

*Your award-winning
complete door and window
hardware solutions partner.*



Brands



www.uapcorporate.com
sales@uaplimited.com
0161 796 7268

UAP Limited
Unit 1 Albert Close Trading Estate
Whitefield
Manchester
M45 8EH
England, UK